

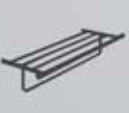

Pakai[®]
since 1969
www.pakai.com



KITCHEN & BATHROOM SOLUTIONS

CATALOGUE 2020



ABOUT US

Pakai has been manufacturing and distributing Kitchen and Bathroom products solutions for over 50 years since 1969.

With customers and distributors located all across Asia in Thailand, Sri Lanka, Myanmar and Malaysia, we specialise in Kitchen and Bathroom products both for the projects and wholesale markets.

We believe in building mutually beneficial partnership for long term sustainability. We believe that a loyal customer is a satisfied and happy customer. We prioritize making our customers happy and building long term relationships by ensuring our customers receive products that best suit their needs.



CONTENTS



- 4 | Cold Tap (Flat / Crown Series)
- 5 | Sensor Tap
- 6 | Barrier Free Living
- 8 | Baby Changing Stations
- 9 | WC Flush Valve
- 10 | Receptacle Paper Tower Dispenser
- 11 | Waste Receptacle Paper Tower Dispenser
- 12 | Paper Holder, Shelf & Hook
- 13 | Floor Grating
- 15 | Bottle Trap
- 16 | WC Connector
- 17 | Shower Rose & Shower Arm
- 18 | Hand Shower & Shower Rail
- 19 | Shower Rose & Hand Shower
- 20 | Hand Spray Bidet
- 22 | Plastic Cistern
- 23 | Toilet Seat & Cover

COLD TAP (FLAT / CROWN SERIES)



FT - PT - B
Pillar Tap (Big Body)



FT - PT - S
Pillar Tap (Small Body)



FT - TWT
Two Way Bip Tap



FT - WST
Wall Sink Tap



FT - BT (Short)
Bib Tap



FT - HBT (Short)
Hose Bib Tap



FT - SC
1/2" Concealed Stop Cock
(Quarter Turn)



FT - PST
Pillar Sink Tap



FT - AV
Angle Valve



CRW-PT-S
Pillar Tap



CRW-PT-LS
Pillar Tap (Long Spout)



CRW-WST
Wall Sink Tap



CRW-HBT
Hose Bib Tap



CRW-BT
Bip Tap



CRW-AV
Angle Valve



AV 300
Angle Valve



CRW-SC
1/2" Concealed Stop Cock
(Quarter Turn)



T7-1117-FT
1/2" Full Turn Concealed Stop Cock

T7-1117B-FT
3/4" Full Turn Concealed Stop Cock

T7-1117A-FT
1" Full Turn Concealed Stop Cock



CRW-PST
Pillar Sink Tap

SENSOR TAP



SF5012BP
Sensor Tap - Pillar
AC 230V / DC Battery Operated



SF2011BP
Sensor Tap - Pillar
AC 230V / DC Battery Operated



SF20125BP
Sensor Mixer - Pillar
With Temperature Control
AC 230V / DC Battery Operated



SF20193BW
Sensor Tap - Wall Mount
AC 230V / DC Battery Operated



SF20512BW
Sensor Tap - Wall Mount
AC 230V / DC Battery Operated

SELF CLOSING TAP SERIES



CF 100 BP
Self Closing Tap



CF 104 BP
Self Closing Tap



CF 105BP
Self Closing Tap



CF 102 BW
Wall Mounted Self Closing Tap



CF 103 BW
Wall Mounted Self Closing Tap

HAND DRYER



HD - 2006HD
ABS Casing
Available in white or silver



HD - 5803ESS
Stainless Steel Casing



HD-2803K
ABS Casing

BARRIER FREE LIVING

GRAB BAR (Nylon)



BF- 880123

Wall Mount U-Bar with Floor Anchoring.
Stainless Steel with antibiosis
colored nylon - white
D: 600 x 700(H)
35mm Ø



BF- 88053

Wall Mount Swing up U-Bar
Stainless Steel with antibiosis
colored nylon - white
D: 600 / 700
35mm Ø



BF- 88493

Wall Mount Swing up U-Bar
floor support stainless steel with
antibiosis colored nylon - white
D: 600 x 700(H)
35mm Ø



BF- 88083

Angled Grab Wall Mount Bar
Stainless Steel with antibiosis
colored nylon - white
D: 600 x 700 / 600 x 600
35mm Ø



BF- 8809-3

Wall Mount Angled Grab Bar
Stainless Steel with antibiosis
colored nylon - white/yellow
D: 700 x 500
35mm Ø



BF- 8903

Wall Mount Angled Grab Bar
Stainless Steel with antibiosis
colored nylon - white
D: 500 x 700
35mm Ø



BF- 8810

Wall Mount Straight Grab Bar
Stainless Steel with antibiosis
colored nylon - white
L: 600 / 700 / 800
35mm Ø



BF- 8902

Wall Mount Straight Grab Bar
Stainless Steel with antibiosis
colored nylon - white
L: 600 / 700 / 800
35mm Ø



BF- 8806-3

Wall Mount Angled Grab Bar
Stainless Steel with antibiosis
colored nylon - white
D: 500 x 700
35mm Ø

*suitable for used with urinal bowl



BF- 8890

Adjustable mirror with
wall mount support.
Mirror Size: 500 x 500
Grab Bar Length : 500mm

GRAB BAR (Stainless Steel)



BF-8811SS
Wall Mount U-Bar with
Floor Anchoring
Stainless Steel SUS304
D: 600 x 700 (H)
32mm Ø



BF-8813
Wall Mount U-Bar
Stainless Steel SUS304
D: 600 / 700
32mm Ø



BF-8818SS
Wall Mount Angled Grab Bar
Stainless Steel SUS304
D: 600 x 600 / 700 x 700
32mm Ø



BF-8817SS
Angled Grab Wall Mount Bar
Stainless Steel SUS304
D: 600 x 700 / 600 X 600
32mm Ø



BF-8861SS
Wall Mount Swing Up U-Bar
Stainless Steel SUS304
D: 600 / 700
32mm Ø
(without spring effect)



BF-8874SS
Wall Mount Swing Up U-Bar
Stainless Steel SUS304
D: 600 / 700
32mm Ø
(with spring effect)



BF-8823SS
Wall Mount Straight Grab Bar
Stainless Steel SUS304
L: 600 / 700 / 800
32mm Ø



BF-8904SS
Wall Mount Straight Grab Bar
Stainless Steel SUS304
L: 600 / 700 / 800
32mm Ø



*suitable for used with urinal bowl

BF-8821SS
Wall Mount Angled Grab Bar
Stainless Steel SUS304
L: 500 x 700
32mm Ø

BABY CHANGING STATIONS



BF- 8909

Baby Changing Station
Wall Mount Horizontal Version
D: 550(H) x 860(W) x 145(D)



BF-8909-2

Baby Changing Station
Wall Mount Horizontal Version
D: 550(H) x 860(W) x 145(D)



BF-8910

Baby Seat
Wall Mount Vertical Version
D: 310(W) x 510(H) x 140(D)



BF-8909-4

Baby Changing Station
Wall Mount Vertical Version
D: 860(H) x 550(W) x 145(D)

SHOWER SEAT



BF- 8887

Wall Mount Swing up Shower Seat
Stainless Steel with antibiosis
colorized nylon - white



BF -8905

Wall Mount Swing up Shower Seat with Floor Support
Stainless Steel with antibiosis
colorized nylon - white

WC FLUSH VALVE



CF 522 WC
Exposed Flush
Valve for Pedestal WC



CF 522 SQ
Exposed WC Flush
Valve for Squatting Pan



CF 523 SQ
Concealed WC Flush Valve
for Squatting Pan



CF 523 WC
Concealed Flush Valve
for Pedestal WC



CF 524 WC
Delay Action Concealed
Low Pressure Flush Valve



CF - SCDA01
Concealed self closing valve

URINAL FLUSH VALVE



CF 501 UR
Exposed Urinal Flush Valve
c/w Rubber Inlet Spud,
Semiflex Flush Pipe & Flange



CF 502 UR
Exposed Delay Action Urinal Flush
Valve c/w Rubber Inlet Spud,
Semiflex Flush Pipe & Flange



CF 503 UR
Concealed Duct Type
Urinal Flush Valve

SENSOR FLUSH VALVE



UF-SEN155PK
Concealed Box Type Sensor Automatic
Urinal Flush valve With Manual Override Button.
Faceplate Size: 115mm(W) x 155mm(H)
Operated by: AC 220V / DC Battery



WF-SEN125PK
Concealed Box Type Sensor Automatic
WC Flush valve With Manual Override Button.
Faceplate size: 133mm(W) x 180mm(H)
Operated by: AC 220V / DC Battery



MANUAL FLUSH VALVE



UF-CB23PK
Concealed Box Type Manual
Push Button Urinal Flushvalve
Faceplate Size: 123mm(W) x 155mm(H)



WF-CB18PK
Concealed Box Type Manual
Push Button WC Flushvalve
Faceplate Size: 123mm(W) x 155mm(H)



WF-CB8106PK
Concealed Box Type Push Button
WC Flush valve with Vacuum Breaker
Faceplate Size: 200mm(W) x 200mm(H)

RECEPTACLE PAPER TOWER DISPENSER

PK-REC-PTD-1400S

Recessed Paper Towel Dispenser / Waste Receptacle

Models Available : SS-REC-PTD-1400S Recessed Model
: SS-REC-PTD-1400S-E Surface Mounted Type
Gross Weight : 11.20 kg

Dispenses 700 multi-fold paper towels. Uncovered, removable, leak-proof. Whole unit is made of heavy gauge SU304 stainless steel with tumbler locks.

Installation : Requires rough wall opening
288mm(W) x 1383mm(H) x 105mm(D)

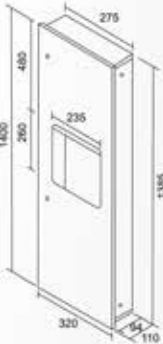

PK-REC-PTD-790

Recessed Paper Towel Dispenser / Waste Receptacle

Models Available : SS-REC-PTD-790 Recessed Model
: SS-REC-PTD-790-E Surface Mounted Type
Gross Weight : 6.30 kg

Dispenses 500-600 multi-fold paper towels. Uncovered, removable, leak-proof. Whole unit is made of heavy gauge SU304 stainless steel with tumbler locks.

Installation : Requires rough wall opening
288mm(W) x 773mm(H) x 105mm(D)



PK-REC-3+1HD

Towel Dispenser / Automatic Hand Dryer / Waste Receptacle
3-in-ONE

Models Available : SS-REC-3+1
3-in-ONE Recessed
: SS-REC-3+1-E
3-in-ONE Surface Mounted
Gross Weight : 23.5 kg

MATERIALS COMPOSITION

NOVATEC 3 in One is fabricated of type 304 (18-8), Stainless steel with exposed surface in architectural satin finish.

DOOR is also fabricated of type 304 (18-8), stainless steel, with maximum rigidity couple with concealed full length stainless steel piano hinges and 3 tumbler locks like other units.

PAPER TOWER DISPENSER is fabricated of type 304 (18-8), stainless steel.

HAND DRYER is of heavy-duty automatic model and (infra-Sensor) touch-free type powered by AC220-240v.

WASTE RECEPTACLE is fabricated of type SU304 (18-8), stainless steel with capacity of 4.5 gal.

Installation : Requires rough wall opening
288mm(W) x 1678mm(H) x 165mm(D)

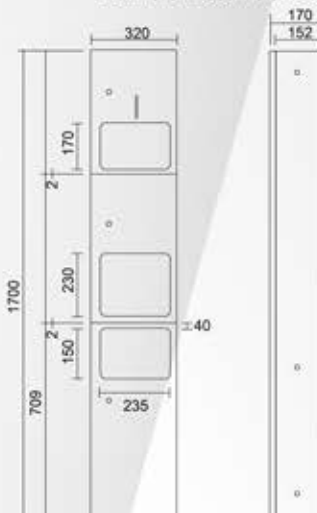

PK-REC-2+1HD

Automatic Hand Dryer / Waste Receptacle
2-in-ONE

Models Available : SS-REC-2+1
2-in-ONE Recessed
: SS-REC-2+1-E
2-in-ONE Surface Mounted
Gross Weight : 16.5 kg

SPECIFICATIONS

Hand Dryer is of heavy-duty automatic (infra-Sensor) touch-free type powered by AC220-240v.

WASTE RECEPTACLE is fabricated of type SU304 (18-8), Stainless steel with capacity of 4.5 gal.

Installation : Requires rough wall opening
288mm(W) x 1222mm(H) x 165mm(D)

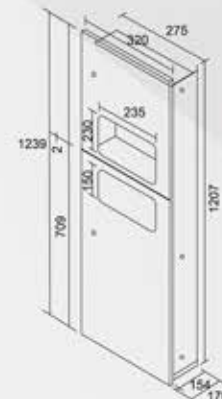

WASTE RECEPTACLE PAPER TOWER DISPENSER

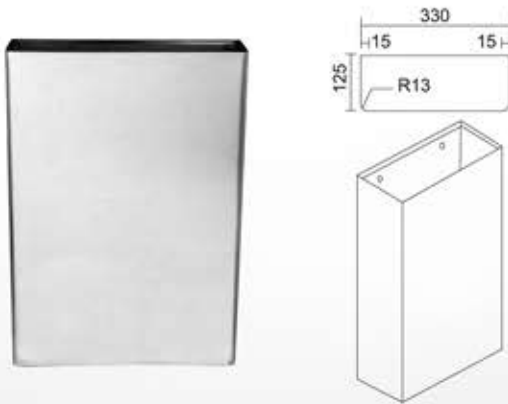

PK-REC-460

Surface-mounted Waste Receptacle
Stainless Steel Bottom Edges Hemmed For Maximum Safety.
Size : 330mm(W) x 460mm(H) x 125mm(D)



PK-REC-SAN-BIN AE-910

Stainless Steel Surface Mounted Sanitary Napkin
Disposal with Lockable Bottom Cover.
Size : 235mm(W) x 279mm(H) x 108mm(D)

TISSUE DISPENSER



SS-PTD-203

Stainless Steel Paper Towel Dispenser
Dimension (HxWxD) : 203mm x 280mm x 120mm
0,8mm #304 Stainless Steel Satin Finished with lock and key
Vol. 250c-fold or 300 multi-fold towels



SSPTD-469

Paper Towel Dispenser
Size : W282mm x D102mm x H365mm
SUS304 Matt Finish



SSJRD-R02

Jumbo Roll Tissue Dispenser
Size : H265mm x W252mm x D112mm
SUS304 Matt Finish



SSJRD-R01

Jumbo Roll Tissue Dispenser
Size : H250mm x W255mm x D125mm
SUS304 Matt Finish

PAPER HOLDER, SHELF & HOOK



SSTPHA43

Polished Stainless Steel
Paper Holder
Size : 138mm x 95mm



SSTPH3910

Satin Stainless Steel
Paper Holder - Double
Size : 270mm x 95mm



SSTPHD457

Satin Stainless Steel
Paper Holder - Double
Size : 457mm x 129mm



SSTPHA119

Concealed Polished Stainless
Steel Paper Holder - Double
Size : 315mm x 165mm x 70mm



SSTPHASRS

Semi Recessed Polished
Stainless Steel Paper Holder
Size : 159mm x 159mm



SSTPH104

Stainless Steel Chrome
Paper Holder



SSTPH105

Stainless Steel
Paper Holder
- Matt Finish



SSTPH106

Stainless Steel
Paper Holder



SSTPH107

Stainless Steel Paper Holder
- Chrome Finish (Grade 201)



SSTPHA120

Concealed Polished
Stainless Steel Paper Holder
Size : 165mm x 165mm x 70mm



SSTPH-SHELF-457

Satin Stainless Steel Shelving
Size : 457mm x 129mm



SSTPH3911

Satin Stainless Steel
Paper Holder



DRH28708

Robe Hook - Matt Mix Polish



DRH-302

Double Robe Hook

SOAP DISPENSER - TISSUE DISPENSER



LSD2501

Liquid Soap Dispenser
Vol : 250ml x 1
Size : H215mm x W50mm
x D65mm
ABS Dark Grey Coating



LSD2502

Liquid Soap Dispenser
Vol : 250ml x 2
Size : H215mm x W100mm
x D65mm
ABS Dark Grey Coating



LSD5003

Liquid Soap Dispenser
Vol : 500ml x 3
Size : H320mm x W150mm
x D65mm
ABS Dark Grey Coating



LSD400C2

Liquid Soap Dispenser
Vol : 400ml
SUS304 Mirror Finish



LSD1000M2

Liquid Soap Dispenser
Vol : 1000ml
SUS304 Matt Finish

FLOOR GRATING



A 101
4" SUS304 Floor Grating
with Curve Height
Thickness : 1.00mm



A 102
6" Plastic Floor Grating



A 103 Mayor (SUS202)
A 104 Pakai (SUS304)
6" S/S Floor Grating
- Thickness 1.0 mm



A 105
4" Plastic Floor Grating



A 106
4" Dia Plastic Floor Grating
(Double)



A 110
6" Plastic Floor Grating
c/w Plastic Strainer



A 111
6" Plastic Detachable
Floor Grating
(For Dry Kitchen only)



A 113
6" SUS304 Floor Grating with Curve
Height c/w Plastic Strainer
Thickness : 1.00mm



A 115
6" SUS304 S/S Floor
Grating with Frame
Cover Thickness : 1.5mm
Frame Thickness : 1.0mm



FA 117 - 6" x 6"
SUS304 Floor Grating with
Insect Resistant Trap
Cover Thickness : 1.2mm
Frame Thickness : 1.0mm



FA 119
SUS304 Decorative Tile
Insect Floor Grating
Size : 150mm x 150mm
Cover Thickness : 1.0mm
Frame Thickness : 1.0mm



FA 121
Floor Frating with
Decorative Tile Tray
c/w SS Tile Tray, SS Frame, ABS
Base & Strainer
Frame Size : 130 x 130 mm
Tray Size : 113 x 113 mm

FLOOR GRATING



FA 120
SUS201 Floor Grating 4" x 4"
For Washing Machine
Matt Finish
Thickness : 2.0mm



FT 151-4
SUS304 Floor Grating 4" x 4"
With Anti Insect Trap in
Satin Finish



FT 154-4
SUS304 Floor Grating 4" x 4"
With Anti Insect Trap in
Satin Finish



FT 152-4
SUS304 Floor Grating 4" x 4"
With Anti Insect Trap in
Satin Finish



FT 153-4
SUS304 Floor Grating 4" x 4"
With Anti Insect Trap in
Satin Finish



FT 133-6
Floor Grating 6" x 6"
With Screw on Cover &
Resistant Trap - Polish Finish

CHANNEL DRAINS



S' - SLOTTED TYPE: ANTI-INSECT / ANTI ODOUR FLOOR DRAINAGE

FT-SCH02-24
600mm x 65mm

FT-SCH02-28
700mm x 65mm

FT-SCH02-36
900mm x 65mm

FT-SCH02-32
800mm x 65mm

FT-SCH02-40
1000mm x 65mm

FT-SCH02-48
1200mm x 65mm

FT-SCH02-44
1100mm x 65mm



**T-TRAY TYPE: ANTI-INSECT / ANTI ODOUR FLOOR DRAINAGE -
CAN BE USED AS TILE INLAY APPLICATION**

FT-SCH01-24
600mm x 65mm

FT-SCH01-28
700mm x 65mm

FT-SCH01-36
900mm x 65mm

FT-SCH01-32
800mm x 65mm

FT-SCH01-40
1000mm x 65mm

FT-SCH01-48
1200mm x 65mm

FT-SCH01-44
1100mm x 65mm

BOTTLE TRAP



A 300 32mm
A 301 40mm
Dia PP Bottle Trap



A 302 32mm
A 303 40mm
Dia CP ABS Bottle Trap



A 306
32mm Dia ABS Bottle Trap
Horizontal Tube : L300mm
Vertical Tube : L250mm



A 307
32mm Dia CP ABS Bottle Trap
Horizontal Tube : L300mm
Vertical Tube : L250mm



A 320
32mm Dia PP Bottle Trap
c/w Intergral Waste, Plug
& Chain



A 310
32mm x 40mm PP
Bottle Trap



A 340 32mm
A 350 40mm
Dia x L100cm Flexible Trap



BBT-3201
32mm Dia CP Bottle Trap
Horizontal Tube : L300mm
Vertical Tube : L150mm



BBT-3202
32mm CP Brass Tubular Trap
Outlet Pipe : L330mm
Vertical Pipe : L180mm

WC CONNECTOR



P 450
4" (100mm) Dia WC
Straight Outlet Connector



P 451
4" (100mm) x 20mm WC
Outlet Connector



P 452
4" (100mm) x 40mm WC
Offset Connector



P 453
4" (100mm) x 90mm Degree
Bend WC Outlet Connector
Max Height: 240mm



P 459
4" (100mm) P to S
Converter



P 457
4" (100mm) Dia WC
Flexible Outlet Trap

WASTE OUTLETS



A 202 32mm
A 203 40mm
Stainless Steel Waste c/w Chromed
Brass Plug & Chain Brass Screw



A 225
40mm CP Brass Flow Waste
c/w Plug & Chain
Height : 45mm



A 200SS 32mm
A 201SS 40mm
Dia. S/steel waste c/w Plug & Plastic
Chain (S /steel Screw)



A 227
32mm S/steel Top Push Up Waste
with ABS Body & Overflow
Height : 80mm

KITCHEN SINK



KSL1066-4

SUS201 SBSD Kitchen Sink
- With Standard Bowl Padding
- w/o Overflow
- c/w 1 1/2" (40mm) waste
- Plate Thickness : 0.4mm
- Lay on edge type
- Size : 1066mm x 457mm x 160mm



DT 1060C

SUS 201 SBSD Kitchen Sink
- c/w 3 1/2" Waste
- Edge design
- 0.4mm thk
- Lay on type
- Size : 1060mm x 455mm x 130mm



KSI 3691-5

SUS 304 SBSD Kitchen Sink
- c/w 3 1/2" Waste
- c/w Table Lock Clip
- c/w Overflow
- Plate Thickness : 0.5mm
- Inset Type
- Size : 914mm x 457mm x 170mm



A 220
32mm CP Brass
Push Up Waste with Overflow
Height : 80mm



A 223-A with Overflow
A 223-B without Overflow
32mm CP Brass Flow Waste
Height : 80mm



A 226
32mm Big Button CP Brass
Push Up Waste with Overflow
Height : 80mm

SHOWER ROSE & SHOWER ARM



A 502
ABS Shower Rose
- 4" Dia Face



A 503 C
CP ABS Shower Rose
- 4" Dia Face



A 520
ABS Hand Shower
c/w 1.5m PVC Hose,
Wall Plug & Screw Set



A 502/6
ABS 4" Dia Ball Joint
Shower Rose c/w L 125mm
Shower Arm



A 503/6 C
CP ABS 4" Dia Ball Joint
Shower Rose c/w L 125mm
Shower Arm



A 566/8 C
CP ABS 3" Dia Ball Joint
Shower Rose c/w L 180mm
Shower Arm



A 506
ABS Shower Arm
- L 125mm



A 507
CP ABS Shower Arm
- L 125mm



A 508 C
CP ABS Shower Arm
- L 180mm



A 513
CP S/Steel Shower Arm
- L 450mm



ASQ-L400
CP Brass Shower Arm
- L 400mm



SA 01
CP S/Steel Shower Arm
- L 180mm

HAND SHOWER & SHOWER RAIL



A551 / WH4C
CP ABS Hand Shower
c/w 1.5m s/s Flexible Hose
& Adjustable Holder
(3 Function)



A551SB
CP SS Rail c/w CP ABS
Hand Shower & 1.5m s/s
Flexible Hose
(3 Function)



NVR-R1
CP S/Steel Rail c/w CP ABS
Shower Holder & Bracket
(18mm Dia x L70mm)



A541SB
CP S/Steel Rail c/w 1 Function
CP ABS Hand Shower & 1.5m
Silver PVC Matt Surface Hose
with Brass Conical Nuts
(Anti Twist)



A541PVB
CP S/Steel Rail c/w 1 Function
CP ABS Hand Shower &
1.5m S/Steel Flexible Hose
(3 Function)



A551PVB
CP S/Steel Rail c/w 3 Function
CP ABS Hand Shower & 1.5m
Silver PVC Matt Surface Hose with
Brass Conical Nuts (Anti Twist)



WH4C
CP ABS Adjustable
Shower Holder



WH5C
CP ABS Adjustable
Shower Holder



WC9Q
Wall Connector
- CP ABS



WH8Q
Wall Connector
- CP ABS



WC8P
Wall Connector
- CP Brass

FLEXIBLE HOSE



A 640 36" (1000mm)
A 641 48" (1200mm)
A 642 60" (1500mm)
Stainless Steel Flexible Hose



A 635 60" (1500mm)
A 636 48" (1200mm)
Silver PVC Matt Surface Hose with
Brass Conical Nuts
(Anti-Twist)

A 634 36" (1000mm)
Silver PVC Matt Surface Hose with
Brass Conical Nuts
(Non Anti-Twist)



DA 650
12" (300mm)
DA 651
16" (400mm)
DA 652
18" (450mm)
DA 653
24" (600mm)
Stainless Steel
Braided Hose



PVC Flexible Hose

AVAILABLE LENGTH

A 620	150mm (6")	A 623	600mm (24")
A 626	200mm (8")	A 630	750mm (30")
A 627	250mm (10")	A 624	900mm (36")
A 621	300mm (12")	A 625	1200mm (48")
A 628	350mm (14")	A 629	1500mm (60")
A 632	400mm (16")	A 631	1800mm (72")
A 622	450mm (18")		

SHOWER ROSE & HAND SHOWER



A 550
CP ABS hand
Shower 9cm Dia.



A 551
CP ABS hand
Shower 4" Dia.
(3 Function)



A 556
CP ABS 4" Dia,
Hand Shower
(3 Function)



A 575
CP ABS 4" Dia
Camellia Hand Shower



A 568
CP ABS 4" Dia
Acacia Multi Spray
Shower Rose
(5 Function)



A 554
CP ABS 4" Dia
Shower Rose
(5 Function)



A 566
CP ABS Ivy Shower Rose
- 3" Dia Face



A 555
CP ABS 5" Dia
Shower Rose
(5 Function)



2010
CP ABS 5" Dia
Shower Rose



A 567
CP ABS 4" Dia
Camellia Shower Rose



A 553
CP ABS 8" Dia.
Rain Shower



A 552
CP SS304
Round 8" Ultra
Slim Rain Shower
(T:1.8mm)



ARS 11-8
CP ABS Round Rain
Shower 8" Dia. With Brass
Fitting Mirror Finish (SS back)
(T:18mm)

HAND SPRAY BIDET



A 516 C

Public Spray Bidet c/w
1.2m S/S Flexible Hose, CP ABS
Wall Hanger, Plug & Screw Set



A 517 C

CP ABS Grand Hand Spray Bidet
c/w 1.2m S/S Flexible Hose, CP
ABS, Wall Hanger & Screw Set



A 518 C

CP ABS Choice Hand Spray Bidet
c/w 1.2m S/S Flexible Hose, CP ABS,
Wall Hanger & Screw Set



A 521 C

CP ABS Comfort Hand Spray
Bidet c/w 1.2m S/S Flexible Hose,
CP ABS, Wall Hanger, Plug & Screw Set



A 522

Brass Hand Bidet c/w 1.2m
S/S Flexible Hose, CP
Wall Hanger



A 524

CP ABS Hand Bidet c/w 1.2m
SS Flexible Hose, CP ABS
Wall Hanger
(Brass Capnut & Spindle)



A 525

Matt Silver Choice
Hand Spray Bidet
c/w 1.2m PVC Matt Silver
Hose c/w Conical Nuts
(Anti-Twist)



A 516 HD

Public Spray
Nozzle only
-CP ABS / White



A 518 HD

Choice Spray Bidet Only
- CP ABS / White



A 517 HD

Grand Spray Bidet Only
- CP ABS / White



A 521 HD

Comfort Spray Bidet Only
- CP ABS / White

HAND SPRAY BIDET



A 516

Public Spray Bidet c/w
1.2m PVC Flexible Hose,
Wall Hanger, Plug & Screw Set



A 516 B

Public Spray Bidet c/w
1.2m PVC Flexible Hose,
Wall Hanger, Plug & Screw Set



A 517

Grand Hand Spray Bidet c/w
1.2m PVC Flexible Hose, Wall
Hanger & Screw Set



A 517 B

Grand hand Spray bidet c/w
1.2m PVC Flexible Hose, Wall
Hanger & Screw Set
(4 parts CP ABS)



A 518

Choice Hand Spray Bidet c/w
1.2m PVC Flexible Hose, Wall
Hanger, & Screw Set



A 518 B

Choice Hand Spray Bidet c/w
1.2m PVC Flexible Hose, Wall
Hanger, & Screw Set
(4 parts CP ABS)



A 521

Comfort Hand Spray Bidet c/w
1.2m PVC Flexible Hose, Wall
Hanger & Screw Set



AZ 1950

EcoRinse Bidet Adapter c/w
Plastic Hose Connection &
Double Nozzle for Cold Water



A 526

Dasha Hand Spray Bidet c/w 1.2m
PVC Flexible Hose, Wall Hanger
* Direct Spray (DS)
* Side Spray (SS)



A 526 C

Dasha Hand Spray Bidet c/w 1.2m
SS Flexible Hose, CP Wall Hanger
* Direct Spray (DS)
* Side Spray (SS)

PLASTIC CISTERN



CT 201 Inspire

Application: High Level
Capacity: 9.0L / 6.0L
Flushing Mechanism: Lift Up Valve
with Metal Pull Chain Handle



CT 401 4.5L (1 Gallon)

CT 402 9.0L (2 Gallon)

CT 403 11.0L (2.5 Gallon)
Auto Flushing Cistern (for Urinal Bowl)



CT 204 Twins

Application: Low Level / Mid Level
Capacity: 9.0L / 4.5L or 6.0L / 3.0L
Flushing Mechanism:
Dual Flush Round Push Button



CT 303 Union Twins

Application: Low Level / Mid Level
Capacity: 9.0L / 4.5L or 6.0L / 3.0L
Flushing Mechanism: Dual Flush Round
Push Button c/w Medium Seat &
Cover & Link Set
***(product not inclusive of WC)**



TOILET SEAT & COVER



SC 100
Mayor PP Light Duty
Seat & Cover



SC 101
Lavender PP Light
Duty Seat & Cover



SC 103
Protea PP Light
Duty Seat & Cover



SC 201
Monaco PP Medium
Duty Seat & Cover



SC 203
ABS Duo Seat & Cover
with Potty Aid Child Seat



SC 301
Avon PP Heavy
Duty Seat & Cover



SC 404BX-00
Ashley Soft Close Seat with
Adjustable Stainless Steel Hinge,
Top Fixing (PP Material)



SC 402
Aster PP Soft Close
Heavy Duty Seat & Cover



SC 104
Cosmos PP Medium
Duty Seat & Cover



SC 401
Joywash PP Soft Close
Bidet Seat & Cover c/w 18"
Stainless Steel Flexible Hose



SC 403BX-00
Mizu Wash Bidet Seat (D - Shape)
Soft Close Function



PAKAI INDUSTRIES BERHAD (8334-U)

Email: sales@pakai.com

Website: www.pakai.com

SANIEURO SDN BHD (0661733-V)

Email: sales@sanieuro.com

Website: www.sanieuro.com

Lot B-LG-1, Connaught Avenue, Jalan 9,
Taman Bukit Cheras, 56000 Kuala Lumpur, Malaysia.

Tel: +603 9108 2199

Fax: +603 9108 3199

SANIEURO THAI CO., LTD.

343/25-26 Thanon Klong Lam-Jiag Nuanchan,
Buengkum Bangkok 10230, Thailand.

Tel: +662 1053401 / 105 3409-10

Fax: +662 105 3400

Email: sales.th@sanieuro.com

Website: www.sanieuro.com/th

NOVATEC SANITARYWARE LANKA (PVT) LTD

No. 9, Chilaw Road, Negombo, Sri Lanka

Tel: +94 31 4936843 / 31 4936847

Fax: +94 31 2223535

Email: sales.lk@sanieuro.com

sales.novateclanka@gmail.com

Website: www.sanieuro.com/lk

SANIEURO MYANMAR CO., LTD.

No. 12, Room 7, Parami Road, Chaw Dwin Gone,
Ma Yan Gone Township, 11061 Yangon, Myanmar.

Tel: +959 450 33 5111

Email: sales.mm@sanieuro.com

Website: www.sanieuro.com/mm

 @pakaiib

 pakai_industries_berhad

 Pakai Industries Berhad

Hashtag: #pakaiib #sanieuro



ISO 9001:2015