



# NYLON SERIES

Anticorrosive aluminium inner core with antibacterial Nylon coating.

Made of aluminium core with Stainless steel wall brackets and 4mm thick Nylon coating which gives the bar high resistance and durability. This is essential for the good maintenance of the external and internal parts of the grab bar.

The Nylon coating is produced from powder format polymers enriched with highly effective bactericidal additives, added during the forming process.

Proven bactericidal effectiveness against the more threatening bacteria in hospitals and medical centres such as: Escherichia coli, Salmonella enteritidis, Staphylococcus aureus and Listeria monocytogenes. The 99.9% reduction within the following 24 hours, being reduced to less than 5% at the first 2 hours.

There is a full range counting with all the typologies that you may need: straight bars, angled bars, swing-up bars, reinforced, with floor supports, for shower, shower seats, handles, etc.

Non-conductive material: no earth grounding means required.

Comfortable touch non-slip

Fixing materials included.

The bactericidal properties and the soft and warm finish make the new NOFER Nylon Series the best choice for the healthcare and hospital environment.



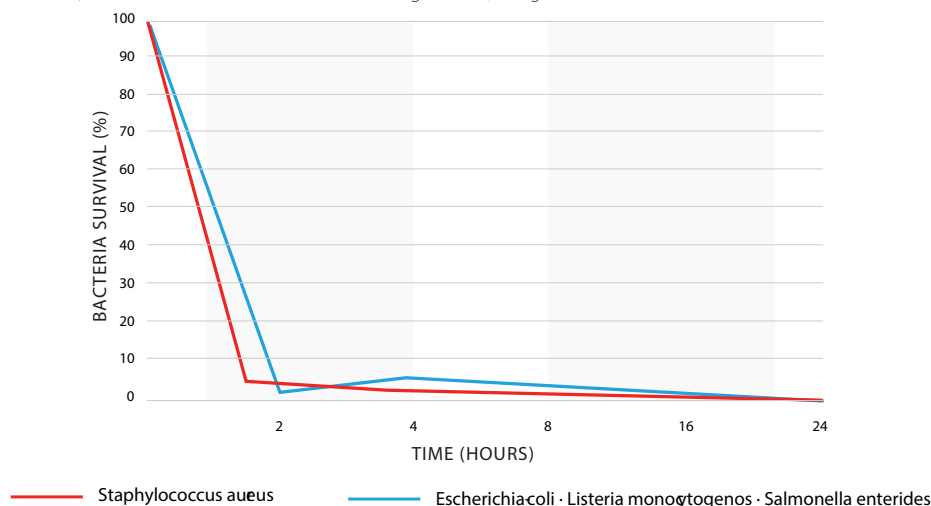



99,9% bacterial reduction within the following 24 hours, being reduced to less than 5% at the first 2 hours.



## Straight grab bars

Straight grab bars made of Aluminium with antibacterial Nylon coating. Stainless steel fixing points with Nylon flange covers.

Finish  
White

Code	Dimensions	Length
<b>15054.30.NBA</b>	Dimensions 300 mm	 300 mm
<b>15054.40.NBA</b>	Dimensions 400 mm	 400 mm
<b>15054.50.NBA</b>	Dimensions 500 mm	 500 mm
<b>15054.60.NBA</b>	Dimensions 600 mm	 600 mm
<b>15054.73.NBA</b>	Dimensions 730 mm	 730 mm
<b>15054.90.NBA</b>	Dimensions 900 mm	 900 mm
<b>15054.120.NBA</b>	Dimensions 1200 mm	 1200 mm

## Swing-up grab bar

Antibacterial Nylon coated steel swing-up grab bar. AISI 304 Stainless steel wall support with antibacterial Nylon flange cover.

Finish  
White

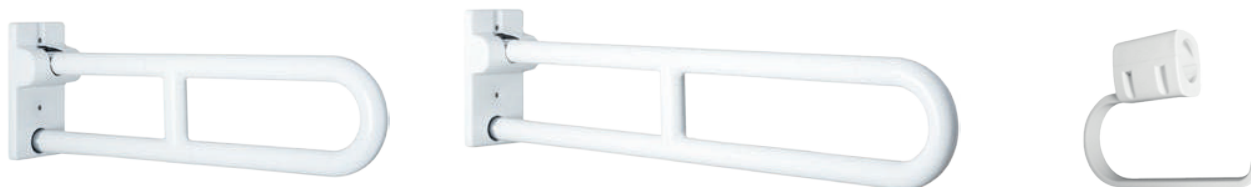

**15051.60.NBA**  
Dimensions  
600 mm

**15051.80.NBA**  
Dimensions  
800 mm

**15051.NBA**  
Nylon toilet paper holder for  
swing-up grab bar

Grab  
BARS

**nylon**   
BY NOFER

 dal 1925  
**GIAMPIERI**  
rubinetterie milano

Material  
Antibacterial Nylon  
coated Aluminium.  
AISI 304 Stainless  
steel wall supports  
with Nylon flange  
covers

Finish  
WHITE (.W)

Bar diameter  
34 mm

## Angled grab bars



**15158.NBA**

Dimensions  
700 x 400 mm



**15159.NBA**

Dimensions  
700 x 400 mm



**15060.NBA**

Dimensions  
600 x 600 mm



**15052.NBA**

Dimensions  
700 x 700 mm



**15158.120.70.NBA**

Dimensions  
1200 x 700 mm

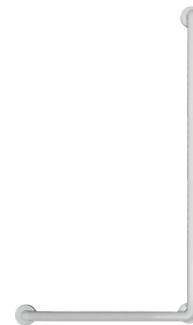

**15159.120.70.NBA**

Dimensions  
1200 x 700 mm



**15049.NBA**

Dimensions  
800 x 700 x 700 mm



**15050.NBA**

Dimensions  
800 x 700 x 700 mm



**15209.NBA**

Nylon shower head support for bars  
Ø 34 mm



**15206.NBA**

Swing-up grab bar with floor  
adjustable foot  
Dimensions  
Length 800 mm



**15064.NBA**

Swing-up grab bar with floor anchoring  
Dimensionstotales  
793 x 150 x 860 mm  
Altura de apoyo  
750 mm



**15203.NBA**

Wall-floor grab bar with double floor  
support. Reversible position.  
Dimensions  
733 x 102 x 733 mm



**15047.60.NBA**

Grab bar with three wall fixing  
points. Reversible position.  
Dimensions  
Length 600 mm



**15047.80.NBA**

Grab bar with three wall fixing  
points. Reversible position.  
Dimensions  
Length 800 mm



**15070.NBA**

Handle  
Dimensions  
Length 120 mm



**15071.NBA**

Single hook  
Dimensions  
95 x 85 x 102 mm

## Foldable shower seats



Material  
Antibacterial  
Polypropylene.  
AISI 304 stainless  
steel wall fixations

 **15042.MOV.NBA**

Removable folding shower  
seat with backrest  
Dimensions Finish  
480 x 420 x 480 mm WHITE (.W)



Material  
AISI 304  
Stainless steel  
Finish  
SATIN (.S)  
POLISH (.B)  
WHITE (.W)



**15065.S**

Phenolic seat with wall  
support  
Dimensions  
388 x 456 x 420 mm



Material  
Aluminum  
polypropylene  
Finish  
WHITE (.W)



**15035.W**

Seat Aluminum and polypropylene  
with floor support  
Dimensions  
480 x 360 x 407 mm



New Generation Hand Dryers



PROBABLY  
THE MOST  
POWERFUL  
IN THE  
WORLD

2  
INJECTION  
LINES

ANTI-  
BACTERIA  
MICROBAN®

ULTRA-FAST  
DRYING  
6 SECONDS



**01305.W**

Maximum hygiene hand dryer

CASING

ABS

POWER

1760 W

DIMENSIONS

617 x 300 x 195 mm

WEIGHT

9,55 Kg

OPERATION

Automatic start when the user inserts hands in the drying area.

Ultra-fast drying system by high speed air currents. Mode of use: insert hands into the drying area, moving them up and down.

OPTIONALLY AVAILABLE

HEPA filter, ZeroSmell, ZeroSmell gel CK1 and Ion Shield

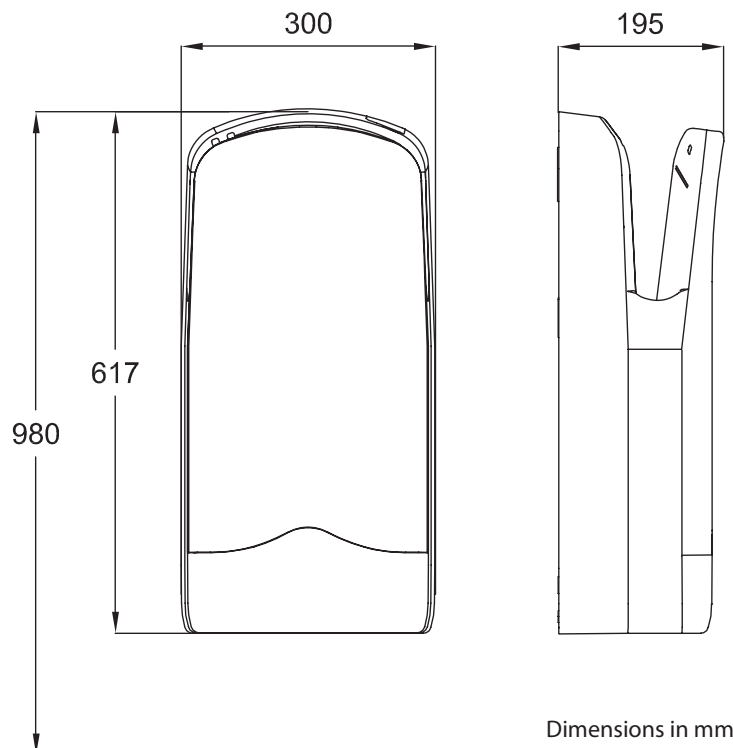

Dimensions in mm





Hand dryer with electronic sensor

**POWER**

800 W

**WEIGHT**

4,9 Kg

**DIMENSIONS**

323 x 253 x 152 mm

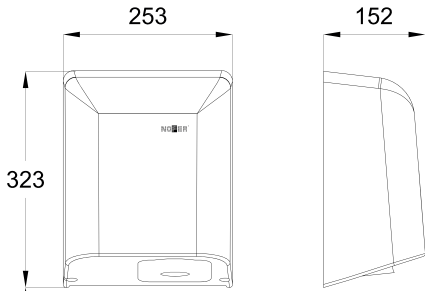

1250

Dimensions in mm



**01851.S**

**CASING**

AISI 304 stainless steel.  
Thickness 1,2 mm

**CASING FINISH**

SATIN



**01851.W**

**CASING**

Steel.  
Thickness 1,2 mm

**CASING FINISH**

WHITE

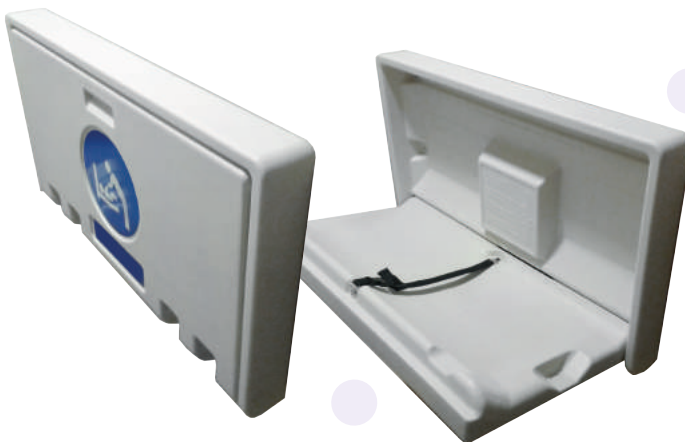

**09209**

Wall mounted horizontal baby changing unit. Permanent antimicrobial protection

**MATERIAL**

High density polyethylene

**DIMENSIONS**

587 x 895 x 529 mm (open)

587 x 895 x 113 mm (closed)



**09211**

Wall mounted baby chair. Permanent antimicrobial protection

**MATERIAL**

High density polyethylene

**DIMENSIONS**

476 x 311 x 317 mm (open)

476 x 311 x 143 mm (closed)



# KING KHALID AIRPORT SAUDI ARABIA



# KEMPINSKI HOTEL CAIRO



# ALEXANDRIA AIRPORT EGYPT



# EMAAR SHOPPING MALL TURKEY - ISTANBUL

## Sanieuro Sdn. Bhd.

Lot B-LG-1, Jalan 9, Connaught Avenue,  
Taman Bukit Cheras, 56000  
Kuala Lumpur, Malaysia  
Whatsapp: +6012 388 3707  
Office : +6039108 2199  
Fax: +603 9108 3199  
Email: sales@sanieuro.com  
Web: www.sanieuro.com

## Sanieuro Thai Co., Ltd.

343/25-26 Thanon Klong Lam-Jiag  
Nuanchan, Buengkum Bangkok 10230,  
Thailand.  
Tel: +66(0) 2105 3401  
Fax: +66(0) 2105 3400  
Email: sales.th@sanieuro.com  
Web: www.sanieuro.com/th

## Novatec Sanitaryware Lanka (Pvt) Ltd.

No 9, Chilaw Road, Dalupotha Negombo  
Showroom: 67, Colombo Road,  
Negombo, Sri Lanka  
Phone: +9431 222 3535 /+9431 493 6847  
Call: +9477 387 6700 / +9477 103 8899  
Email: sales.lk@sanieuro.com  
sales.novateclanka@gmail.com  
Web: www.sanieuro.com/lk

## Sanieuro Myanmar Co., Ltd.

No.12, Room 7, Parami Road, Chaw Dwin  
Gone, Ma Yan Gone Township, 11061  
Yangon, Myanmar.  
Phone: +9594 5033 5111  
Office: +0926 748 1769  
Email: sales.mm@sanieuro.com  
Web: www.sanieuro.com/mm

Business group:

